

VIEW A

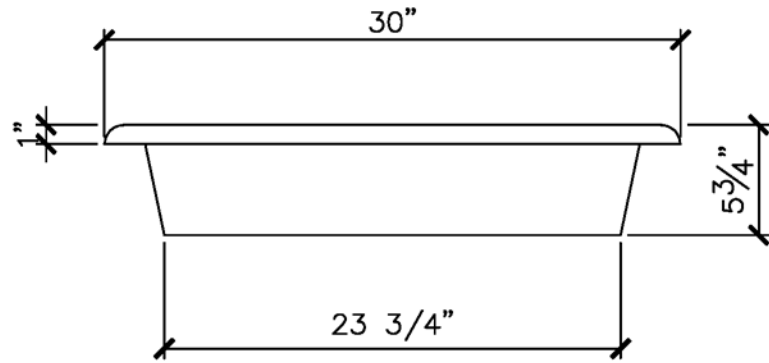

VIEW B

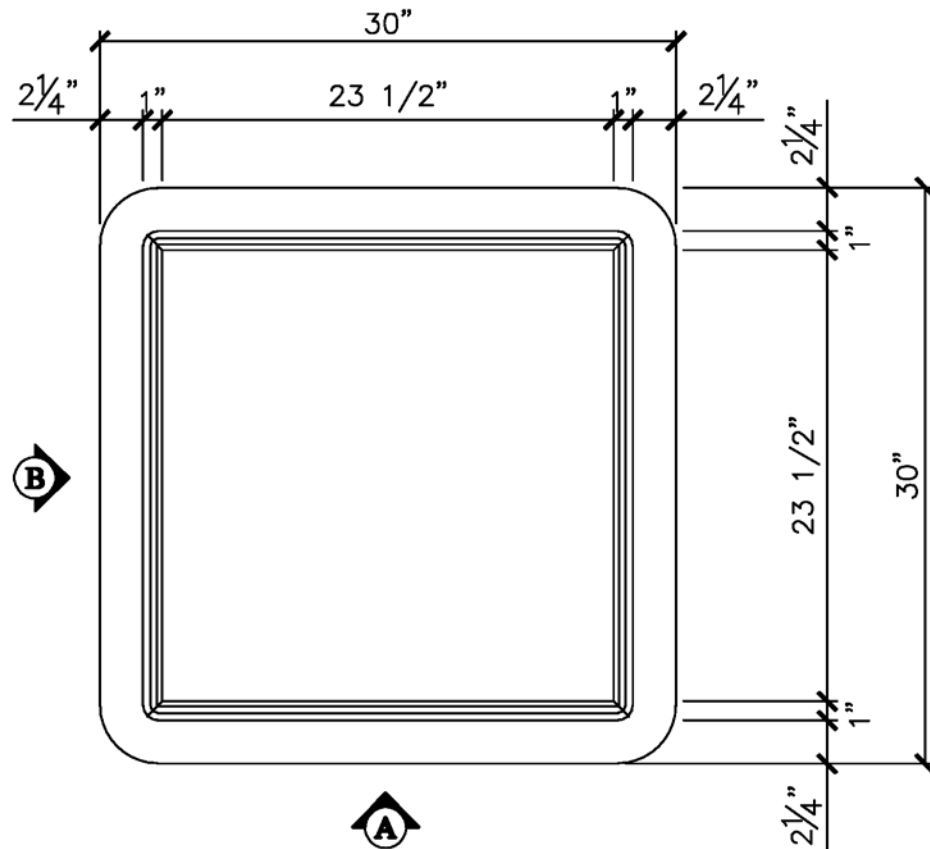

NOTE:
ALL DIMENSIONS ARE IN INCHES UNLESS OTHERWISE SPECIFIED



**10 IMPERIAL GALLON
CONTAINMENT BASIN**

DWG NO:		REV
SCALE:	1:10	