

**VIEW A**

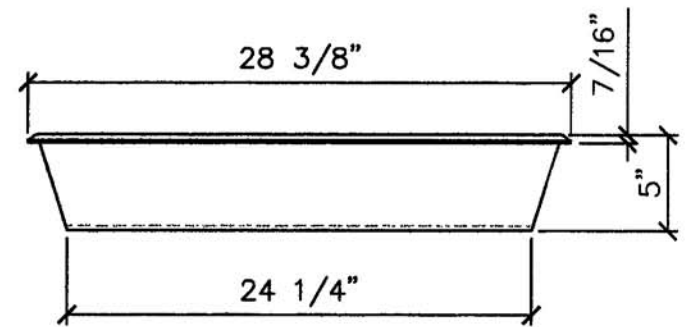

**VIEW B**

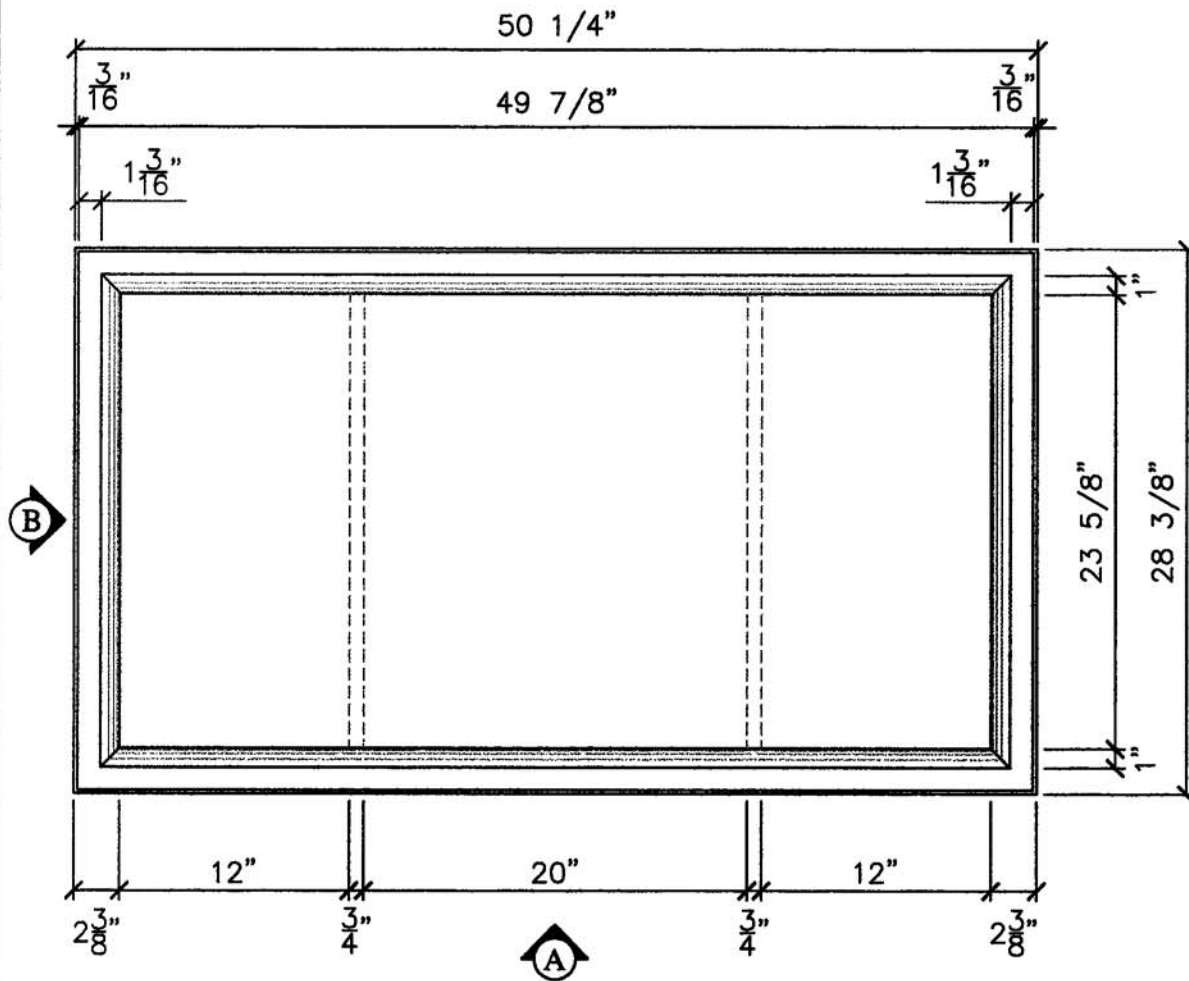

**NOTE:**  
ALL DIMENSIONS ARE IN INCHES UNLESS OTHERWISE SPECIFIED



**20 IMPERIAL GALLON  
CONTAINMENT BASIN**

DWG NO:		REV
SCALE:	1:10	