

VIEW A

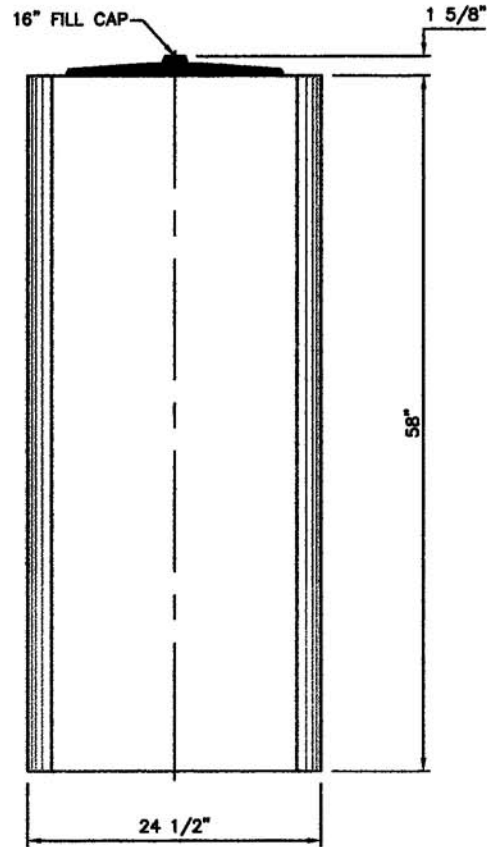

VIEW B

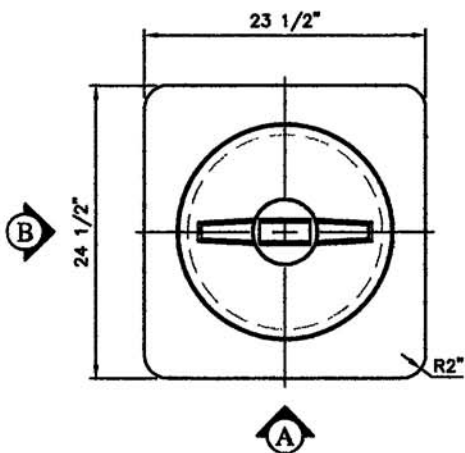

NOTE:
ALL DIMENSIONS ARE IN INCHES UNLESS OTHERWISE SPECIFIED



**115 IMPERIAL GALLON
STORAGE TANK**

DWG NO:		REV
SCALE:	1:16	